

BluCub 3D

By
Gene Bond

Specs:
3mm Depron or split FF
27"ws
~180sqin
5.25oz
4.2oz/sf
17U/25g CDR motor
8040HD prop
2sK340 pack
6s WOT
128w/tb

Aileron cutout
1/2 Wing
(make as 1 whole wing)

wing stiffener
(top and bottom)

13.500

7.000

6"

1/2 wing stiffener
(make as 1 piece 1.5x24")
(top and bottom)

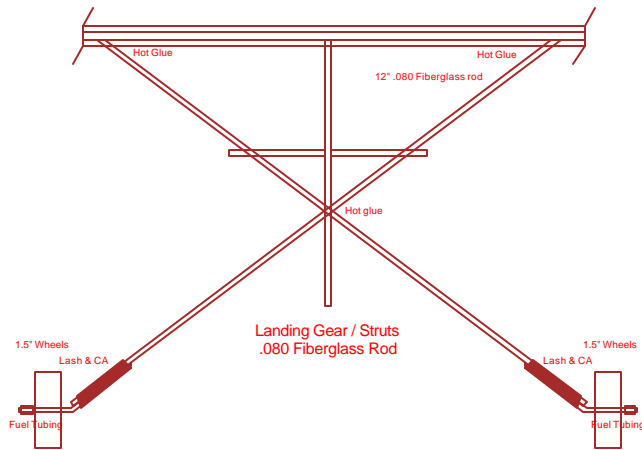
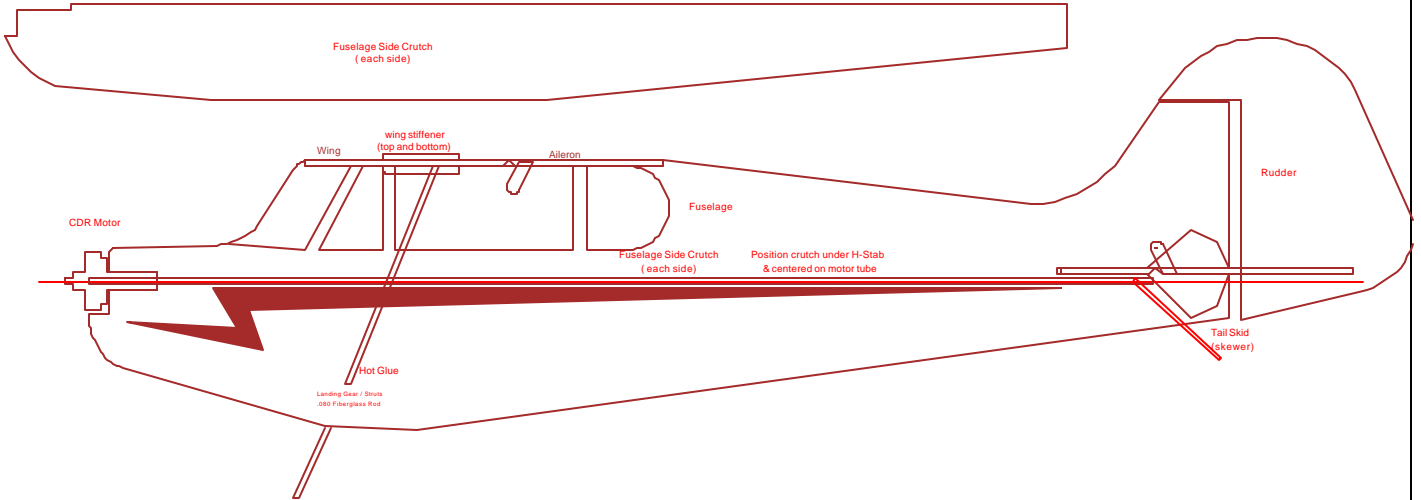
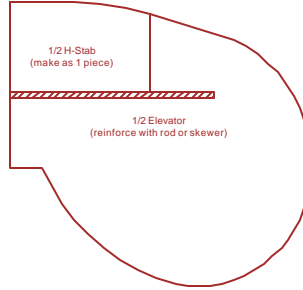

BluCuk

Aileron cutout

1/2 Wing
(make as 1 whole wing)

By

wing stiffener
(top and bottom)

Gene B

13.50

1/2 wing stiffe
(make as 1 piece
(top and botto

3D

Specs:

3mm Depron or split FF

27"ws

~180sqin

5.25oz

4.2oz/sf

17t/25g CDR motor

8040HD prop

2sK340 pack

6a WOT

128w/lb

7.000

ond

0

6"

ner
(1.5x24")
(m)

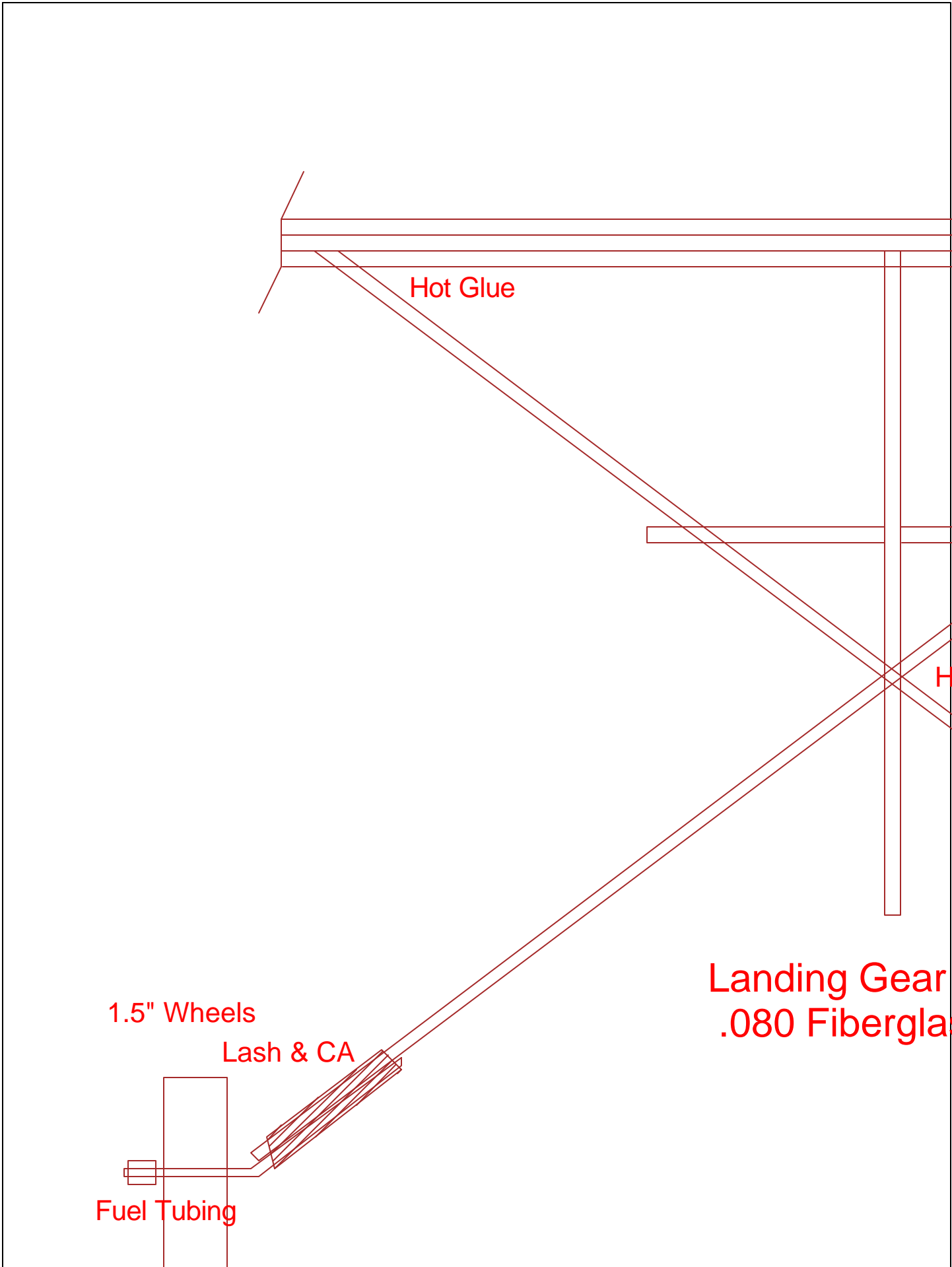

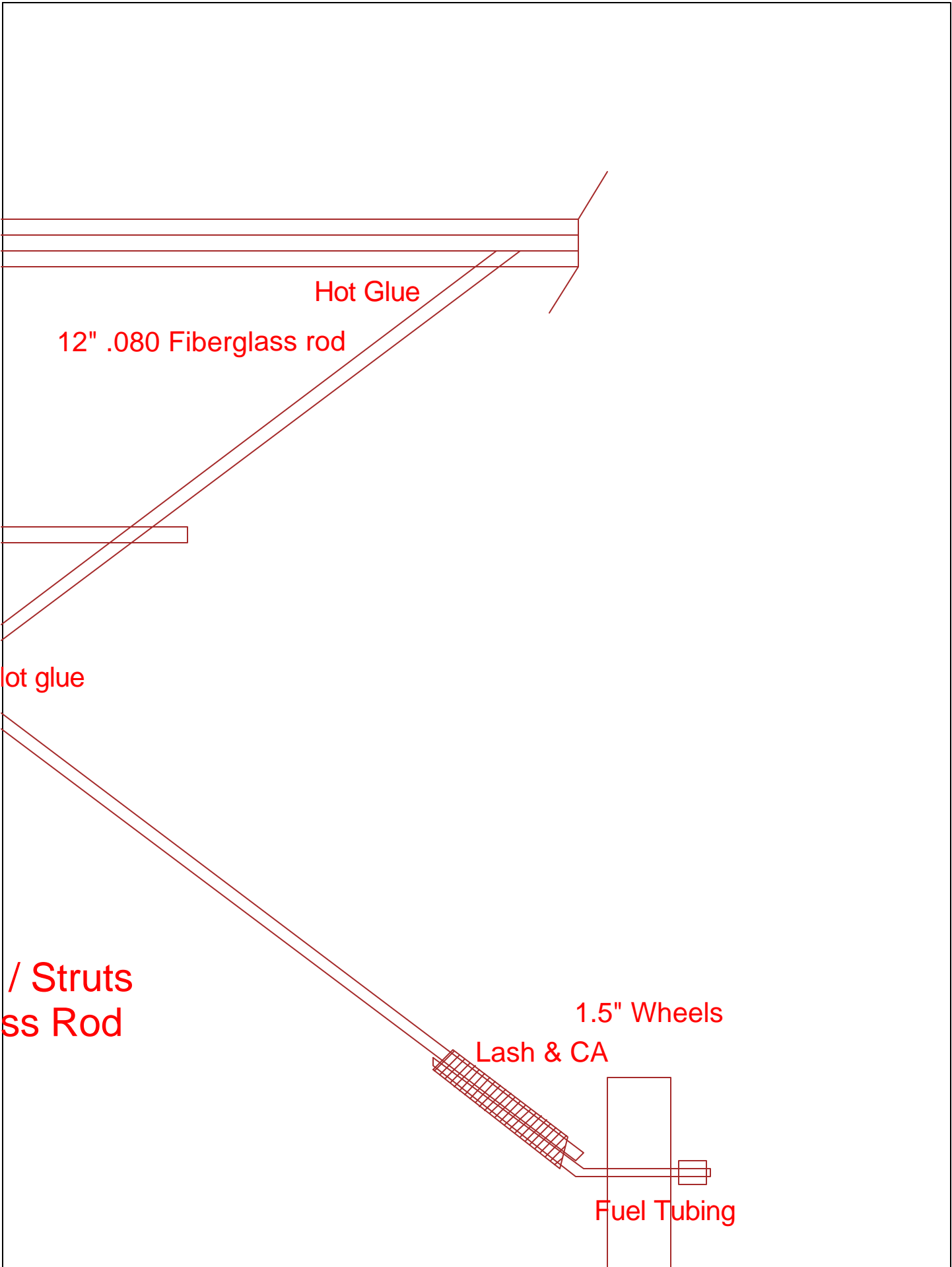

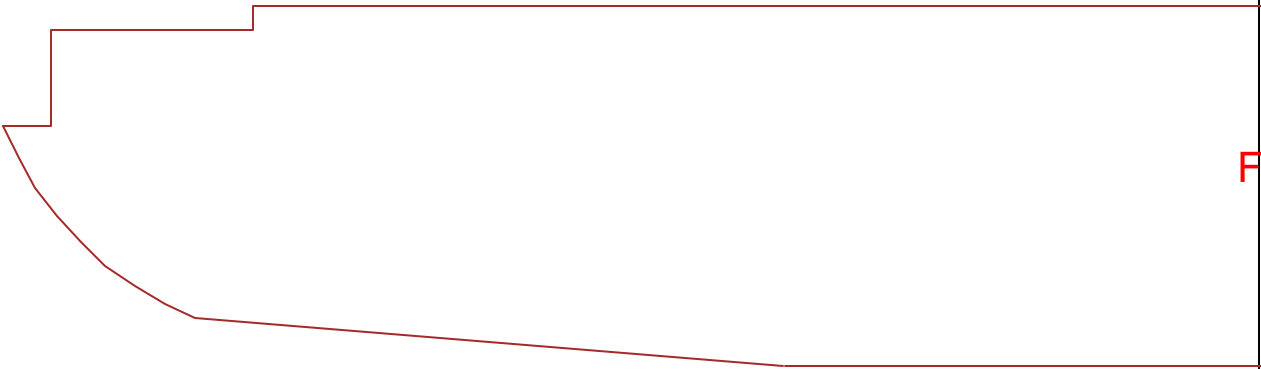

F

Win

CDR Motor

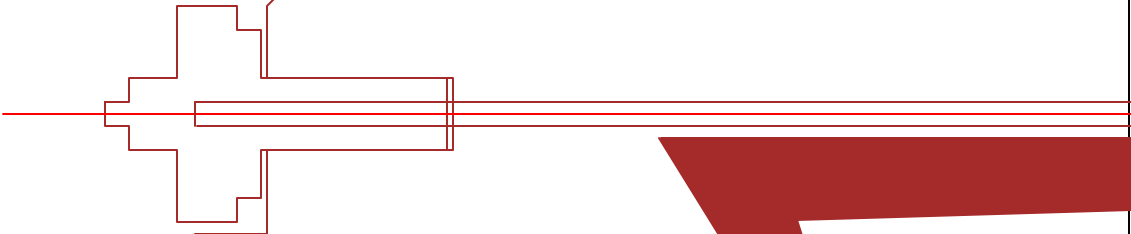

Landin
.080 F

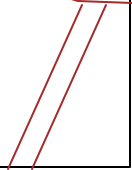

Fuselage Side Crutch
(each side)

wing stiffener
(top and bottom)

Aileron

Fuselage

Fuselage Side Crutch
(each side)

Hot Glue

Wing Gear / Struts
Fiberglass Rod

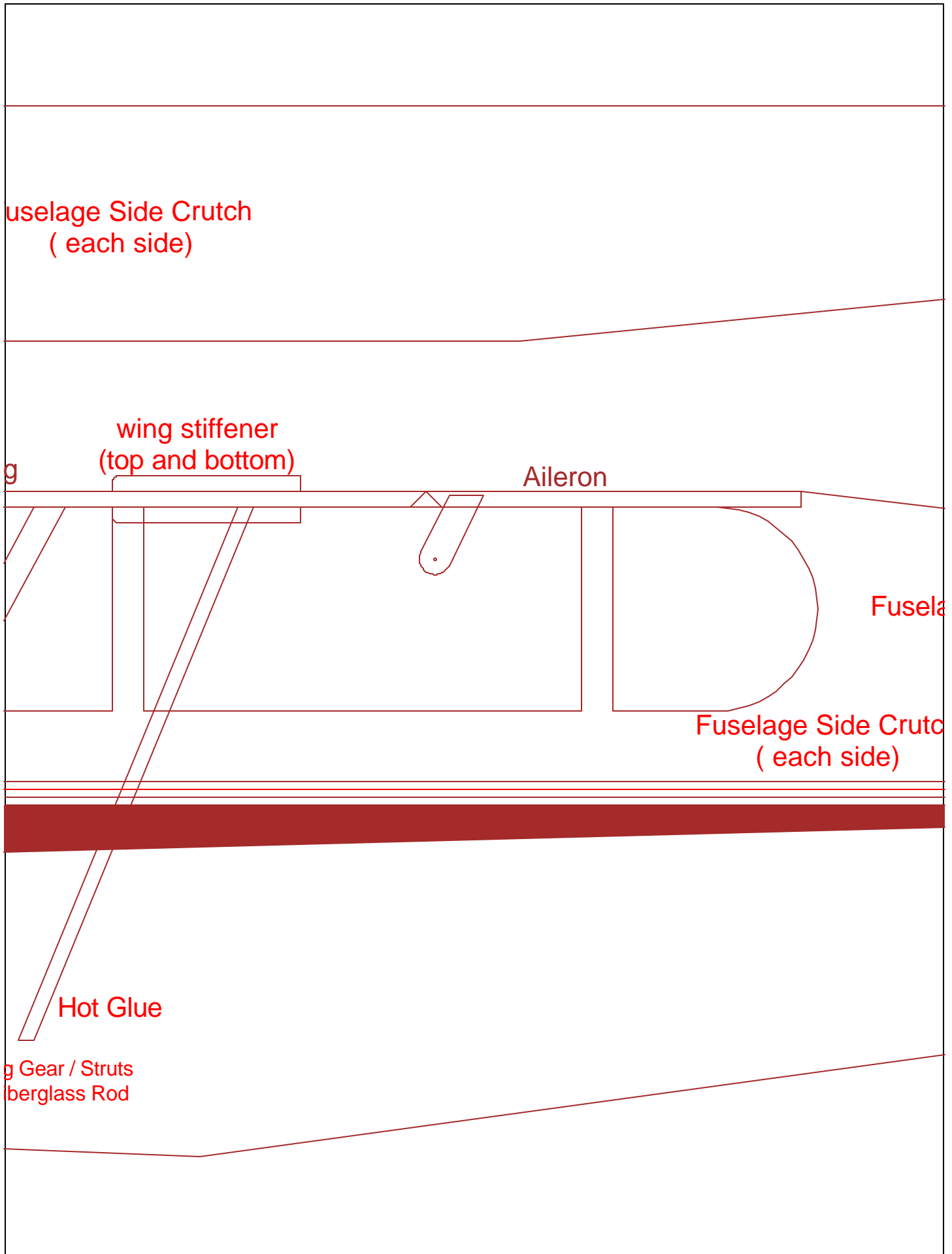

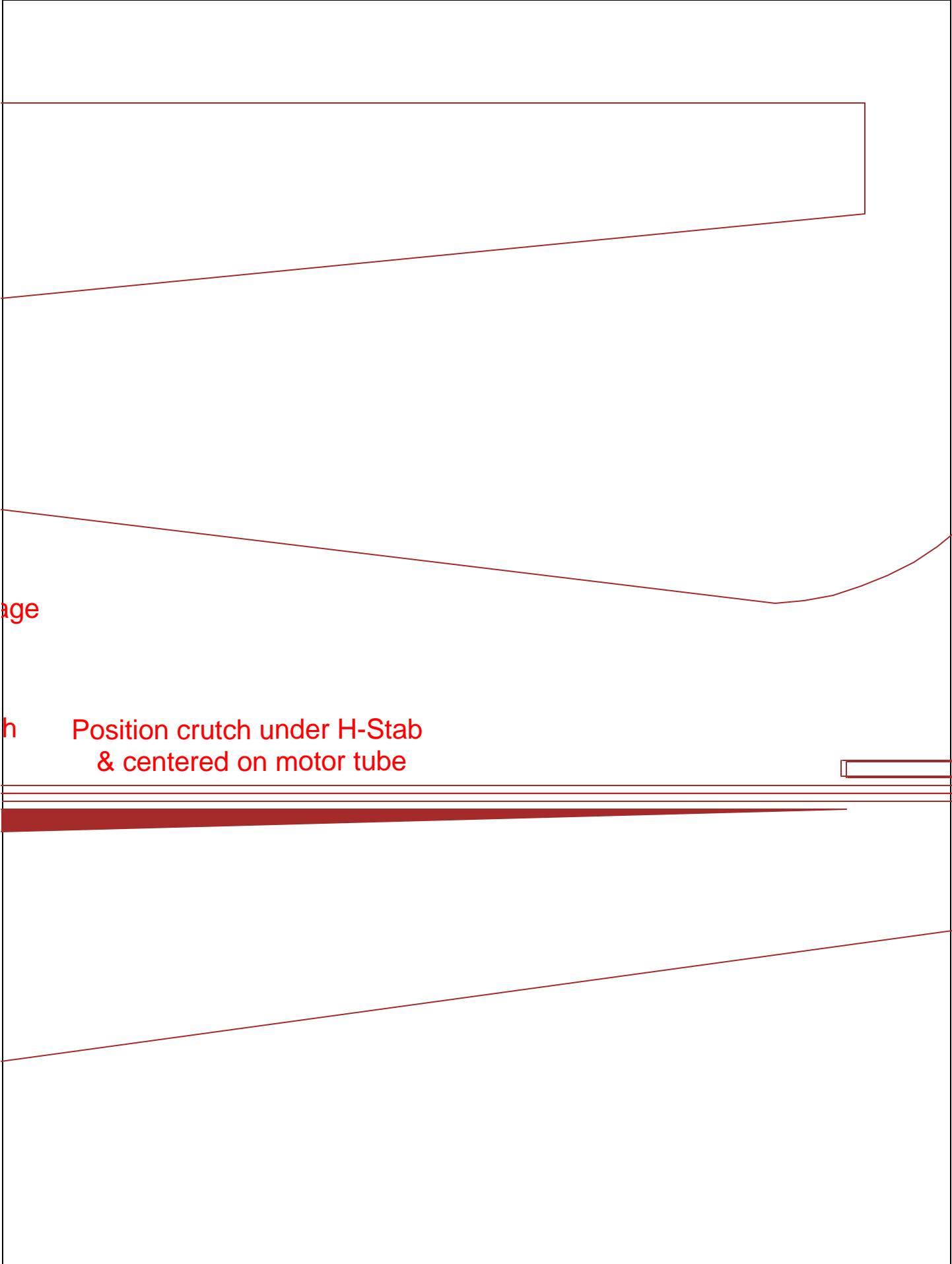

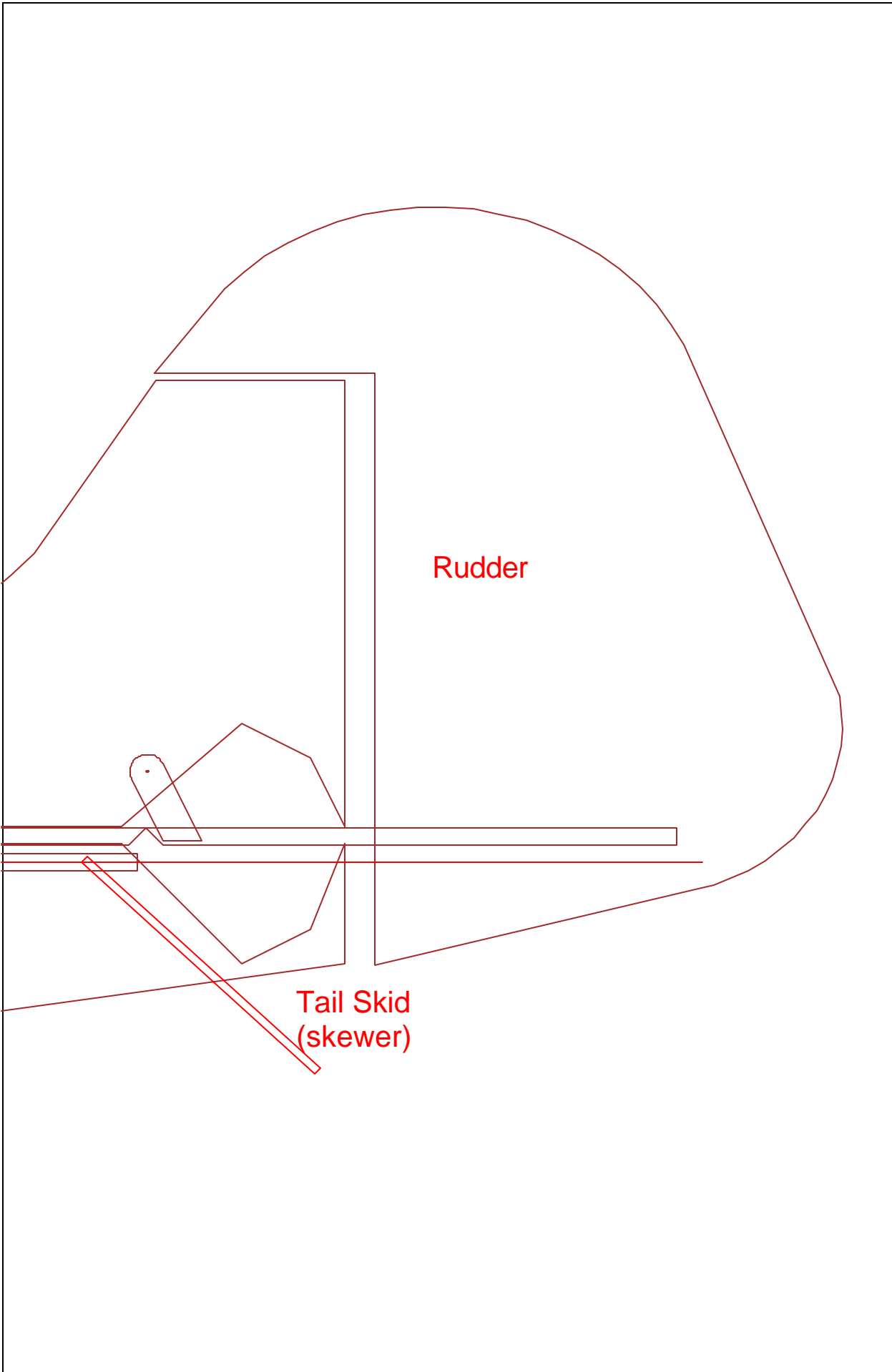

Rudder

Tail Skid
(skewer)

1/2 H-Stab
(make as 1 piece)

1/2 Elevator
(reinforce with rod or skewer)